

PS65M

Power Supply AC/DC

P/N: 211249



Features:

- 65.00W medical AC/DC power supply for worldwide use
- Simple operation
- Country-specific AC input cables available
- LED for status indication

Applications:

Suitable for use with medical applications.

Specification

Input		
Voltage	100.00 to 240.00VAC ±10%, 50-60Hz	
Current	1.60A max.	
Standby power	< 0.21W @ no load	
Output		
Voltage	19.00VDC ± 5%; Ripple < 190mV _{pk-pk}	
Power	65.00W max.	
Current	3.43A max.	
Protection	Short circuit, over-voltage, over-current	
Environmental		
	Operation:	Storage:
Ambient temperature	0°C to 40°C	-20°C to 80°C
Pressure & Altitude	1060hPa to 540hPa -382m to 5000m	1060hPa to 540hPa -382m to 5000m
Humidity (non-condensing)	20 to 80% r.H.	10 to 90% r.H.
Mechanical Details		
Housing dimensions (LxWxH)	119 x 60 x 36mm, without cables and connectors	
Output cable length	1500mm ±30.00mm	
Weight	310g, without input cable	
AC input socket	IEC 320 C8 Type	
Output connector	DC barrel jack, 5.5 x 2.5 x 11mm	
General		
Efficiency	California's Energy Efficiency Level VI	
Cooling	Convection cooled	
Green procurement	RoHS 2011/65/EU + 2015/863/EU REACH 1907/2006 WEEE 2012/19/EU	
MTBF	300,000h at 25°C ambient	
Safety & EMC		
Regulatory approvals	Europe, USA & Canada	ANSI/AAMI/IEC/EN ES60601-1:2012 (60601 edition 3.1) Means of Protection: 2x MOPP UL recognized PSE Jet
EMC	Japan Europe, USA, United Kingdom, Morocco	CE, FCC, UKCA, CMIM IEC 60601-1-2:2014 (edition 4.0) The EMC assessment shall be conducted for the end system configuration.
Energy efficiency	CEC, DoE Level VI	

Recommended Accessories

Type	Product	P/N	Application
2-pol AC-Cable	EU-Version	201496	Country specific power cables
	US-Version	201497	



Drawing

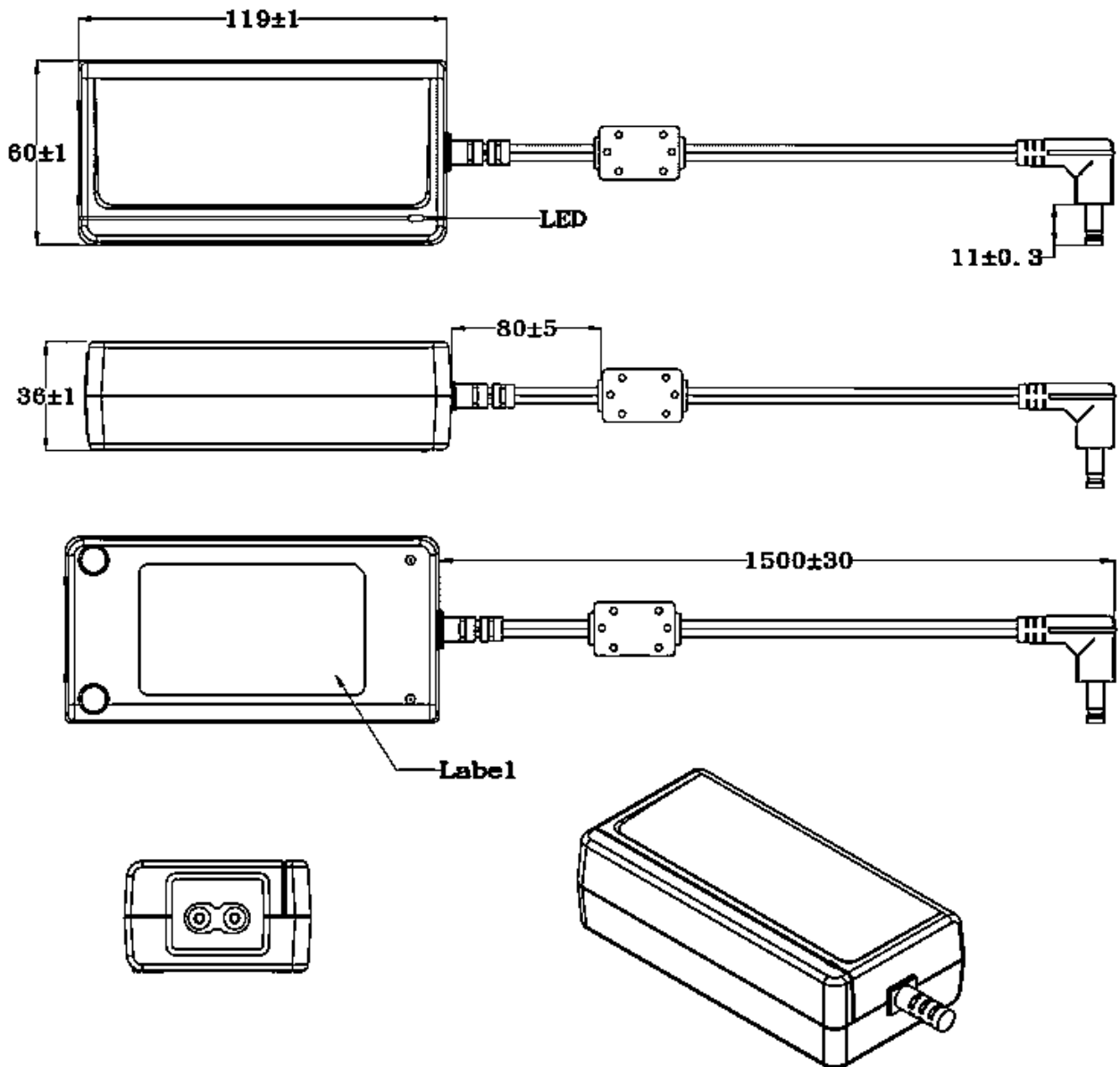

Germany/Headquarters

RRC power solutions GmbH
Technologiepark 1
66424 Homburg / Saar

Tel.: +49 6841 98090
Fax: +49 6841 9809280
Email: sales@rrc-ps.de
Web: www.rrc-ps.com

USA

RRC power solutions Inc.
18340 Yorba Linda Blvd.,
107-437
Yorba Linda, CA 92886

Tel.: +1 714 777 3604
Fax: +1 714 777 3658
Email: usa@rrc-ps.com
Web: www.rrc-ps.com

Hong Kong

RRC power solutions Ltd.
S-V,6/F, Valiant Industrial
Centre 2-12 Au Pui Wan Street
Fo Tan, N.T., Hong Kong

Tel.: +852 2376 0106
Fax: +852 2375 0107
Email: hkrrc@rrc-ps.cn
Web: www.rrc-ps.cn





China

RRC power solutions Ltd.
Room 1306, C Building,
Tianan International building,
Renmin South Road, Luohu
District, Shenzhen 518021

Tel.: +86 755 8374 1908
Fax: +86 755 8374 1861
Email: hkrrc@rrc-ps.cn
Web: www.rrc-ps.cn

RECYCLING INFORMATION

RRC Standard Battery Charger & External AC/DC power supply

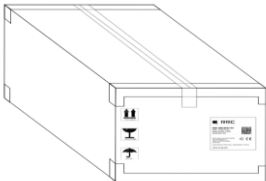
Products	
RRC-SBC2037	RRC-SMB-UBC
RRC-SCC1120	RRC-SMB-UBC-DIS
RRC-SCC1130	RRC-SMB-UBC-M
RRC-SMB-MBC	RRC-SMB-FPC
RRC-SMB-MBC-M	RRC-SMB-DBC
RRC-SCC-EZP	PS65 / PS65M / PS90M
Material	Packaging component
LDPE 4 	PE-Bag 
PAP 20 	Single Box 
	Outer Box 

Pictures only for reference